

BUILT-IN BEVERAGE COOLER

Instruction Manual

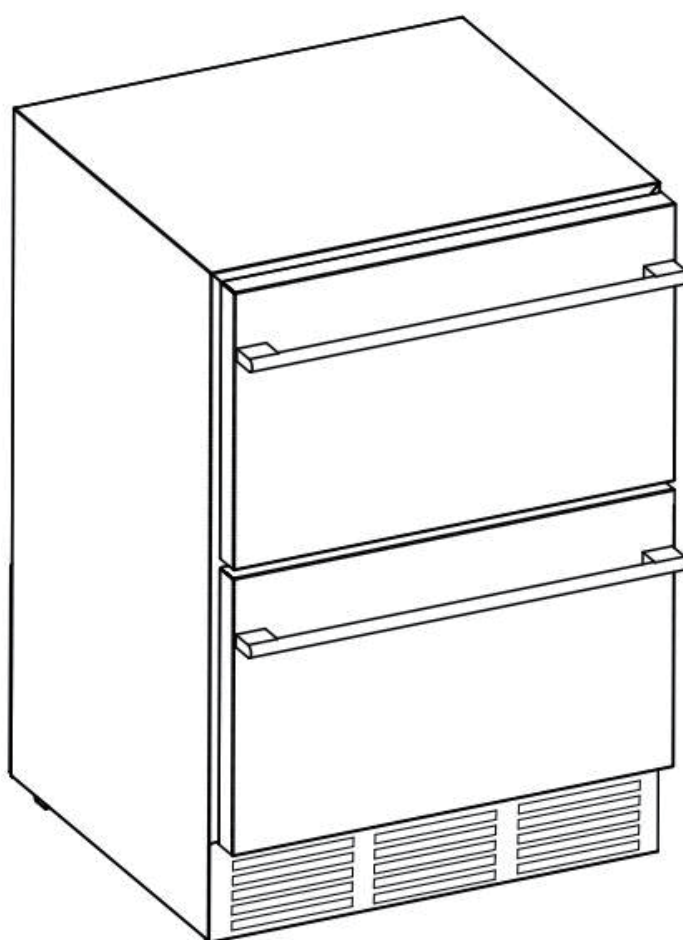

SKU: ZX-RU-DD05-AZ-HM

Email: support@homyd.com

Congratulations

Dear Customer:

Welcome to the our family. Thank you for purchasing one of our products.

Our goal is to provide you with superior service. If there is anything missing from or wrong with your order, or if you have any questions about using our product, PLEASE contact us.

Email: support@homyd.com

Our team is available 24/7 to address your questions, comments, and concerns.

Your satisfaction is our ultimate goal. We want to make everything right so you'll share your positive experience with other shoppers on Amazon.

If you experience any problems, please send an email to support@homyd.com

Our mission:

- * To be the most trusted appliance brand.
- * To create practical, compact appliances that better your life.

Contents

IMPORTANT SAFETY INSTRUCTIONS	1-3
PRODUCT DIAGRAM	4
INSTALLATION INSTRUCTIONS	5-7
OPERATION INSTRUCTIONS	8-9
CARE & MAINTENANCE	10-11
TROUBLESHOOTING GUIDE	12-13

IMPORTANT SAFETY INSTRUCTIONS

Your safety and the safety of others are very important.

This beverage cooler complies with the applicable safety requirements and is safe for daily use. However, basic safety precautions should always be followed when using an electrical appliance, to reduce the risk of fire, electric shock, and personal injury.

DANGER

- Plug the cooler into its own individual electrical outlet with a voltage rating that matches the rating label on the cooler (115/120V AC only, 60Hz, 10A). Use receptacles that cannot be turned off by a switch or pull chain. Be sure that the plug is fully inserted into the receptacle.
- Plug the cooler into a grounded 3-prong outlet. Do not under any circumstances cut or remove the third ground prong from the power cord supplied.
- To protect against electric shock, do not immerse the beverage cooler, plug, or cord in water or other liquids.
- Never unplug the cooler by pulling the power cord. To disconnect the Beverage cooler, always grip the plug firmly and pull it straight out from the wall outlet.
- Repair or replace immediately all power cords that have become frayed or otherwise damaged. Do not use a cord that shows cracks or abrasion damage along its length or at either end.
- Do not connect or disconnect the electric plug when your hands are wet. Do not operate the cooler with wet hands, while standing on a wet surface, or while standing in water.
- Unplug the cooler or disconnect the power before cleaning or servicing. Failure to do so can result in electrical shock or death.
- When moving the cooler, be careful not to roll over or damage the power cord.
- Never clean the beverage cooler parts with flammable fluids, which can create a fire hazard or explosion. Do not store or use gasoline or other flammable materials or liquids in the vicinity of this or any other appliance. The fumes can create a fire hazard or explosion.
- Do not attempt to repair or replace any part of your beverage cooler unless it is specifically recommended in this manual. All other servicing should be referred to a qualified technician.
- An empty beverage cooler can be dangerous to children. Remove any latches, lids, locks, and/or doors from unused or discarded beverage coolers to prevent child entrapment and suffocation. Never allow children to operate, play with, or crawl inside this beverage cooler.

I IMPORTANT SAFETY INSTRUCTIONS

DANGER

- Moving this beverage cooler requires two people. Failure to do so can result in injury.
- Place this beverage cooler in a well-ventilated area with temperatures above 15°C (60°F) and below 32°C (90°F).
- To ensure proper ventilation for your beverage cooler, the front of the cooler must be completely unobstructed.
- This beverage cooler must be installed in an area away from wind, rain, water spray, or drips.
- The beverage cooler should not be located near ovens, grills, or other sources of high heat.
- Do not kink or pinch the power supply cord of the beverage cooler.
- It is important for the beverage cooler to be leveled in order to work properly. You may need to make several adjustments to level it.
- This beverage cooler is designed for storing and cooling beverages. Do not store perishable food or medical products inside the cooler.
- When disposing of refrigeration beverage coolers, special handling is often required. It is the consumer's responsibility to comply with federal and local regulations when disposing of this product.
- **WARNING:** Risk of child entrapment and suffocation. Before you throw away this or any old cooler, remove the door. Leave the shelves in place, so that children may not easily climb inside.

I IMPORTANT SAFETY INSTRUCTIONS



LAMMABLE REFRIGERANT GAS

- **DANGER** - Risk of fire or explosion. Flammable refrigerant used.
- **DO NOT use mechanical devices to defrost the refrigerator. DO NOT puncture refrigerant tubing.**
- **DANGER** - Risk of fire or explosion. Flammable refrigerant used. To be repaired only by trained service personnel. **DO NOT puncture refrigerant tubing.**
- **CAUTION** - Risk of fire or explosion. Flammable refrigerant used. Consult the repair manual / owner's guide before attempting to service this product. All safety precautions must be followed.
- **CAUTION** - Risk of fire or explosion. Dispose of property in accordance with federal and local regulations. Flammable refrigerant used.
- **CAUTION** - Risk of fire or explosion due to puncture of refrigerant tubing. Follow handling instructions carefully. Flammable refrigerant used.
- **CAUTION** - To prevent a child from being entrapped, keep children out of reach of the cooler and not in the vicinity of the cooler.

I PRODUCT DIAGRAM

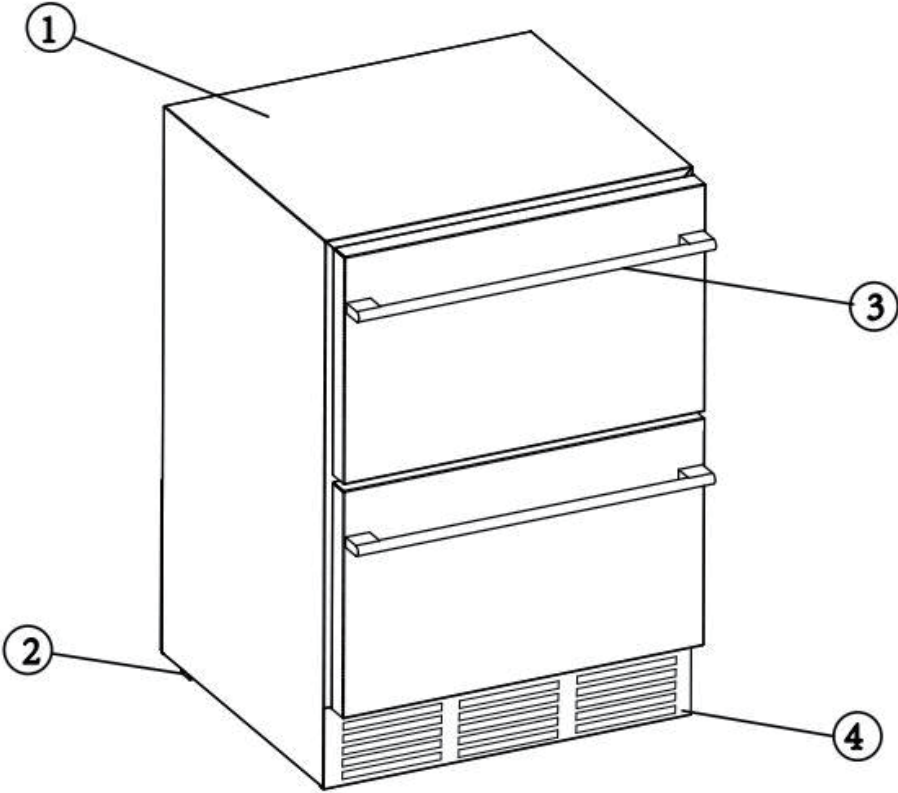

① Cabinet

③ Handle

② Leveling Legs

④ Exhaust window

I INSTALLATION INSTRUCTIONS

Before Using Your Beverage Cooler

- Remove the exterior and interior packaging.
- Check to be sure you have all of the following parts:
 - o Instruction Manual
 - o 2 Extra Screws for Installing Handle
- IMPORTANT:** Before connecting this beverage cooler to a power source, let it stand upright for approximately 24 hours. This will reduce the possibility of a malfunction in the cooling system from handling during transportation.
- Clean the interior surface with lukewarm water using a soft cloth.
- Install the handle on the left side of the door.

Installing the Stainless Steel Handle

- 1) Pull away the door gasket in the area where the handle is to be installed, as in Illustration #1. The gasket is easily removed by hand; no tools are necessary.

- 2) Align the handle with the pre-installed screws on the door frame. Tighten the screws with a screwdriver until the handles are secured tightly against the door frame, as shown in Illustration #2. (Do NOT over-tighten as this will cause damage to the handle assembly).

- 3) Replace the door gasket to its original position.

Note: This beverage cooler includes stainless steel handles that are not required to operate the cooler. If you choose not to use the handles supplied, simply follow step 1 to access the pre-installed screws; remove them and place two decorative plugs (NOT included) into the two holes separately. Continue to step 3 to replace the door gasket to its original position.

INSTALLATION INSTRUCTIONS

Illustration #1

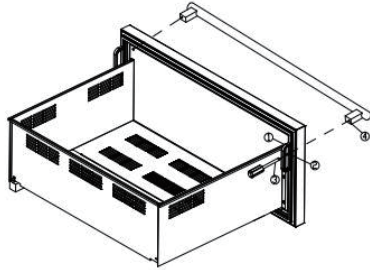
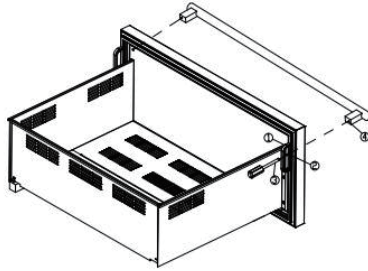
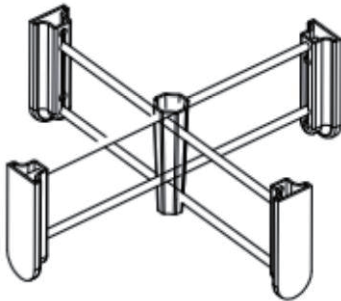
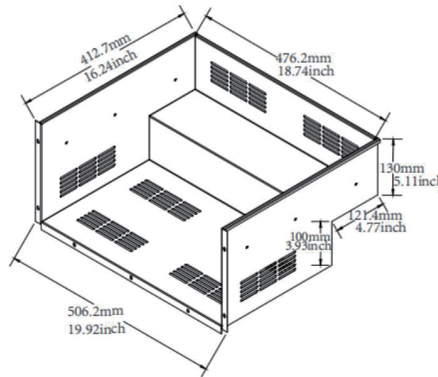
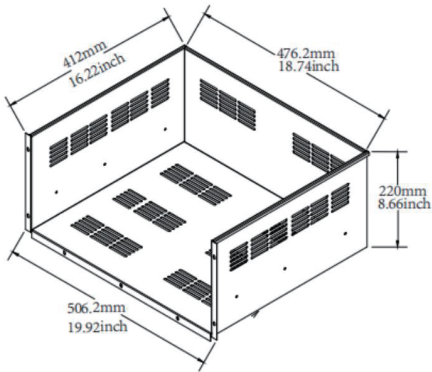

Illustration #2



- 1 Sealing
- 2 Screw
- 3 Phillips screwdriver
- 4 Handle



Each drawer contains a movable grid organizer to keep your food and drinks neat and tidy.

Installing the Beverage cooler

- This beverage cooler is designed for free-standing or built-in (fully recessed) installation.
- Place your beverage cooler on a solid and level floor that is strong enough to support it when it is fully loaded. This will ensure a vibration-free and noise-free operation. Adjust the leveling legs in and out to stabilize the cooler horizontally. If the legs are not properly adjusted, the cooler may be unstable and result in excess noise or vibration.

I INSTALLATION INSTRUCTIONS

- Locate the beverage cooler away from direct sunlight and sources of heat (stove, heater, radiator, etc.). Direct sunlight may affect the acrylic coating, and heat sources may increase electrical consumption. Extremely cold ambient temperatures may also cause the cooler not to perform properly.
- It is not advisable to install this cooler in moist areas or directly adjacent to a kitchen sink, as moisture could cause premature corrosion to the components of your new cooler.
- It is recommended you install the beverage cooler in a place with temperatures **above 60°F (15°C) and below 90°F (32°C)**, and humidity under 60%. If the ambient temperature is above or below recommended temperatures, the performance of the cooler may be affected. Placing your cooler in extremely cold or hot conditions may cause interior temperatures to fluctuate, and the temperature range of 3°C-18°C (37°F-65°F) may not be reached.
- Connect the beverage cooler to an exclusive, properly grounded, standard electrical supply (**115 V AC only, 60 Hz**), in accordance with federal and local electrical codes and ordinances. Any questions concerning power and/or grounding should be directed toward a certified electrician or an authorized products service center.

⚡ Warning ⚡ : Improper use of the grounded plug can result in the risk of electrical shock. If the power cord is damaged, have it replaced by an authorized service center.

- The beverage cooler should always be plugged into its own individual electrical outlet which has a voltage rating that matches the rating label on the beverage cooler. This provides the best performance and prevents overloading house wiring circuits, which could cause a fire hazard from overheating.
- Do not under any circumstances cut or remove the third ground prong from the power cord supplied.
- Do not use an extension cord or adapter plug. However, if you must use an extension cord, it is absolutely necessary that it be a UL-listed, 3-wire grounding type. The beverage cooler extension cord must have a grounding type plug and outlet, and the electrical rating of the cord must be 10 amperes (minimum) and 120 volts.
- Do not use a cord that shows cracks or abrasion damage along its length or at either end.
- If the beverage cooler will be used in an area that is prone to power surges/outages, it is suggested that you use a power surge protector. The surge protector you select must have a surge block high enough to protect the beverage cooler it is connected to. Damage due to a power surge is not considered a manufacturer-covered defect and will void your product warranty.

I OPERATION INSTRUCTIONS

TEMPERATURE SETTING RANGE: 3°C(37°F) and 18°C (65°F)

Recommended temperature settings

Beverage: 3°C -10°C (37°F - 50°F)

Sparkling wines:5°C -8°C (41°F - 46°F)

Dry/white wines: 9°C - 14°C (48°F - 57°F)

Rose Wines 10°C - 11°C (50°F - 52°F)









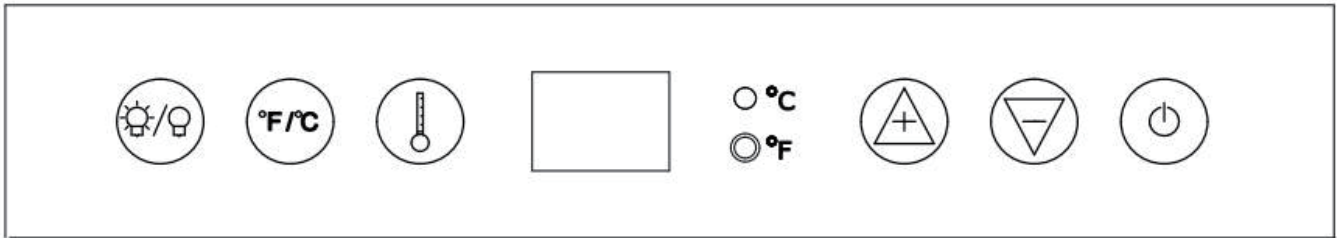

Red wines: 15°C - 18°C (59°F - 64°F)

Controls

Once the beverage cooler is plugged into a wall outlet, it will turn on automatically, and the LCD screen will display the inside temperature of the cooler.

After setting your desired serving temperature, allow the cooler to cool for 3 to 4 hours before placing beverages in the cooler.



	Press once to turn ON the cooler. Press and hold  about 3 seconds to turn OFF
 	Press  to increase or press  to decrease the temperature in 1-degree increments between 3°C and 18°C or between 37°F and 65°F.
	Press to begin adjusting the temperature for the upper or lower zone.
	Toggles the temperature display between Celsius and Fahrenheit
	Press  once to turn the interior light ON or OFF.

I OPERATION INSTRUCTIONS

Storage

Cans and bottles may differ in size and dimensions. As such, the actual number of bottles you may be able to store may vary. This model can store about 98 standard cans.

The standard can as below:

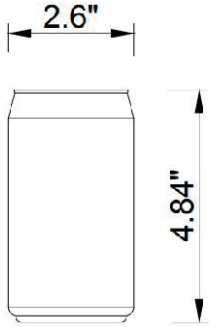

The stated loading capacity is based on the standard-size soda drink, that is, 2.6" in diameter and 4.84" in height.

CARE & MAINTENANCE

Cleaning Your Beverage Cooler

IMPORTANT: Always unplug the cooler before cleaning or performing maintenance. Never use harsh cleansers or scouring pads to clean any part of the cooler.

- Turn off the power, unplug the beverage cooler, and remove all items including shelves.
- Wash the inside surfaces with a warm water and baking soda solution—about 2 tablespoons of baking soda to one quart of water.
- Wash the shelves with a mild detergent solution.
- Wring excess water out of the sponge or cloth when cleaning the area near the controls, or any electrical parts.
Wash the outside cabinet with warm water and a mild liquid detergent. Rinse well and wipe dry with a clean soft cloth. Do not use steel wool or a steel brush to scrub the stainless steel, which would contaminate the stainless steel with steel particles and could cause rusting.

NOTE: If you use our products outdoors, be sure to promptly clean up any dust or water stains to extend the lifespan of the product.

Power Failure

Most power failures are corrected within a few hours and should not affect the temperature of your beverage cooler. If the power is off for an extended period, proper steps should be taken to protect your contents.

Vacation Time

Leave the beverage cooler operating during vacations of less than three weeks. For longer periods, turn the cooler off and leave the door slightly ajar to prevent odor from building up inside the beverage cooler.

I CARE & MAINTENANCE



Moving Your Beverage Cooler

- Remove all items (bottles) from the cooler.
- Securely tape down any loose items, such as shelves, inside the cooler.
- Turn the adjustable leg up to the base to avoid damage.
- Tape the door shut.
- Ensure that the beverage cooler stays securely in the upright position during transportation. Protect the outside of the cooler with a blanket or a similar item.

Energy Saving Tips

- The cooler should be located in the coolest area of the room away from heat sources or direct sunlight.
- Ensure that the cooler is adequately ventilated. Never cover air vents.
- Only open the cooler door for as long as necessary. Frequent opening of the door will affect internal temperature.

I TROUBLESHOOTING GUIDE

PROBLEM	POSSIBLE CAUSE	SOLUTION
The beverage cooler does not run.	The beverage cooler may not be plugged in, or the plug may be loose.	Ensure the beverage cooler has been plugged in properly.
	The beverage cooler is turned off.	Press  to turn on the cooler.
	Blown house fuse or tripped circuit breaker.	Check/replace fuse. Reset circuit breaker.
The beverage cooler is not cold enough.	External environment may require a higher setting.	Set a colder setting. Allow several hours for the temperature to stabilize.
	The beverage cooler has recently been disconnected for a period of time.	It takes 3-4 hours for the beverage cooler to cool down completely.
	Prolonged or frequent door openings	Open the door less often.
	The door is not closed completely.	Close the door properly.
	The door gasket does not seal properly	Check the door gasket. Clean or change gasket if necessary.
The compressor turns on and off frequently.	The room temperature is hotter than normal.	It's normal for the beverage cooler to work harder under these conditions..
	A large amount of content has been added to the cooler.	A large amount of content causes the beverage cooler to run longer until the desired temperature is reached.
	Prolonged or frequent door openings	Open the door less often.
	The temperature has not been set correctly.	Press either  or  to check the set temperature, and set the temperature properly.
	The door is not closed completely.	Close the door properly.
	The door gasket does not seal properly.	Check the door gasket. Clean or change gasket if necessary.

TROUBLESHOOTING GUIDE

PROBLEM	POSSIBLE CAUSE	SOLUTION
The light does not work.	Not plugged in.	Plug the cooler in.
	The circuit breaker tripped or a blown fuse.	Check the breaker and/or fuses.
	The light button is "OFF".	Press  to turn the light ON.
Vibrations.	The cooler is not leveled.	Check to assure that the cooler is level.
	The bottles are vibrating.	Make sure the bottles don't touch each other.
	There is an object under the cooler.	Remove the object under the cooler.
The cooler seems to make too much noise.	The cooler is not level.	Level the cooler.
	Normal noise from the flow of the refrigerant	The rattling noise may come from the flow of the refrigerant, which is normal. As each cycle ends, you may hear gurgling sounds caused by the flow of refrigerant in your cooler. Contraction and expansion of the inside walls may cause popping and crackling noises.
The compressor turns on and off frequently.	The cooler is not level.	Level the cooler.
	The door was reversed and not properly installed.	Re-install the door properly.
	The gasket is dirty.	Clean the door gasket.
	The shelves are out of position	Place the shelves properly.
Moisture build-up on interior or exterior of the beverage cooler.	This is normal during high-humidity periods.	Lower the room humidity.
	This is normal in high-temperature	Move the cooler to a cooler place, and avoid heat and sunlight.
	Prolonged or frequent door openings.	Open the door less often.
	The door does not seal completely.	Check door gaskets for proper seal.
Error Code: E1-E2-E3-E4-E7-E8	A sensor has failed.	Contact customer service.